

Article number: 20193V35V35602SW  
 Description: E+G T-angle clamp  
 GN 193-V35-V35-60-2-SW

## Measures

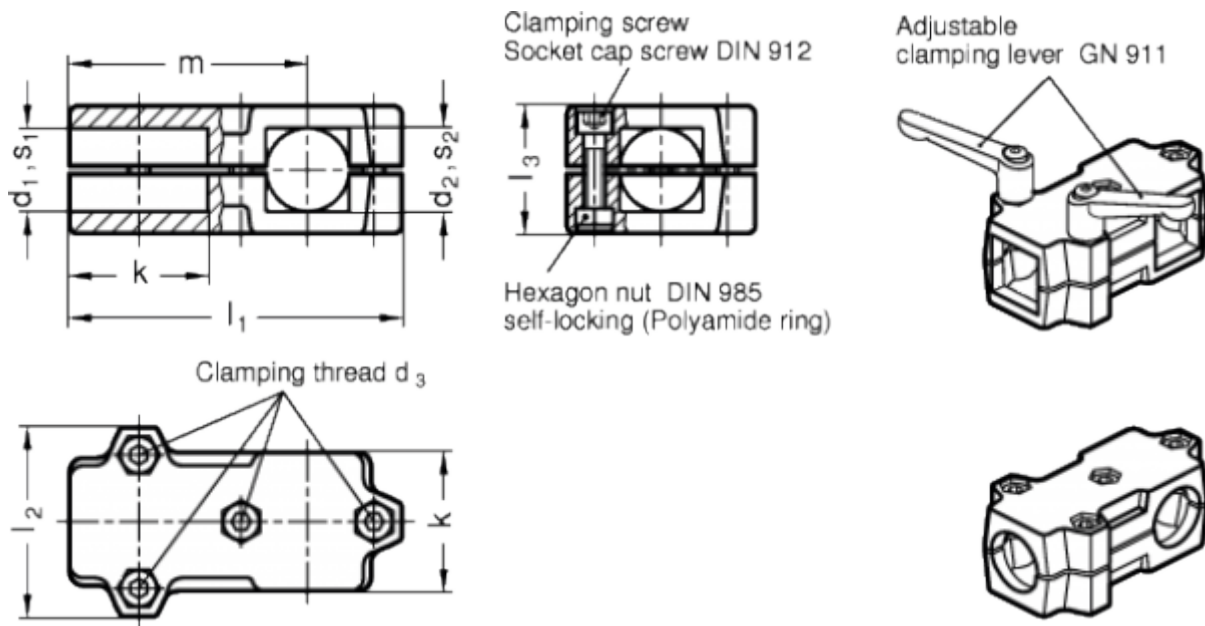

Accessories = GN 911-M8-55	m	= -
d1 = -	s1	= 35
d2 = -	s2	= 35
d3 = M8	Weight in (g)	= 692
k = 60		
l1 = 141		
l2 = 79		
l3 = 59		